



Low voltage AC drives

ABB machinery drives

ACS355

0.37 to 22 kW/0.5 to 30 hp

Catalog

Introduction to ACS355



ABB machinery drives

The ABB machinery drives are designed to be fast drives to install, parameter-set and commission. Thus saving hours of engineering work. They are highly compact and cost-effective. Equipped with cutting-edge intelligence and safety capability the drives are designed specifically to meet the production and performance needs of system integrators, original equipment manufacturers (OEMs) and panel builders, as well as the requirements of end users in a broad range of applications.

In the ABB machinery drives portfolio, ACS355 represents the micro drive range; meeting requirements like compact size, being optimized for a lower power range, cost-effectiveness, and ease of use. By choosing an ABB machinery drive, machine builders not only get all the clever things inside the drive, but also everything outside it: the entire global ABB. This means a full range of products and services designed to support their business.

Applications

ABB machinery drives are designed to meet the requirements of an extensive range of machinery applications. The drives are ideal for food and beverage, material handling, lifting, textile, printing, rubber and plastics, and woodworking applications.

Highlights

- Exceptionally compact drives and uniform design
- Quick commissioning with application macros and panel assistants
- Safe torque off function (SIL3) as standard
- Sensorless vector control for induction motors and permanent magnet motors up to 599 Hz
- Built-in braking chopper
- IP66 product variant for harsh environments and solar pump drive variant available

Contents

2	Introduction to ACS355
4	Little big drives without limiting your business
6	Typical applications
7	How to select a drive
8	Ratings and types
9	Technical data
10	Dimensions and weights
12	Cooling and fuses
13	Control connections
14-15	Control program example
16-17	Control program variants for advanced performance
16	High speed application
17	Enhanced sequence programming
18-19	Product variants for application-specific operation
18	High protection class drive
19	Solar pump drive
20-28	Options
20	Selecting options
21	Interface
23	Software tools
26	External
29	Compact PLC and AC drive starter kit
30-31	ABB automation products
32-33	Drives service



Little big drives without limiting your business

ACS355 drives are designed to maximize your machine's availability with drives that are easy to install and setup. The drive is highly modular and supports a variety of fieldbus protocols thus providing flexible connectivity. In addition to a broad range of built-in options such as different I/O and communications, a wide selection of external accessories is also available. Wherever your machine is located, the local ABB will be there to support you and your clients.

Flexible performance

Reduce the need for external PLC components with built-in sequence programming providing simple drive control logic. Improve production flow and increase cost savings with built-in features, such as speed compensated stop enabling precision stopping, and patented smooth start for permanent magnet motors.

Quick and easy commissioning

Predefined I/O configurations for application macros and built-in assistants speed up commissioning of the drive, allowing you to concentrate on your business.

Compact and uniform design

Compact size, the broadest power range in its class from 0.37 to 22 kW and side-by-side mounting ensure optimized cabinet installation in a wide range of machinery applications, resulting in space and cost savings.

Supported motor types

Same drive can be used for sensorless induction and permanent magnet motor control without a feedback device.



Application-specific product variants

Ensure long life time of equipment and reliable energy supply with a drive for solar pumps including embedded pump-specific features protecting the pump. The high speed variant for spindle applications provides speed controller tuning without use of encoder.

Protection against harsh environments

Increase time and cost savings with NSF certified product variant for IP66/67/69K, UL Type 4X protection classes with no need to design special enclosures for applications that require a high ingress protection against dirt, dust and moisture.

Communication with major automation networks

Optional fieldbus adapters enable connectivity with major industrial automation networks.



Safety

Integrated safe torque off (STO) function up to SIL 3 is a cost-effective and certified solution for safe machine maintenance by fulfilling IEC 61508, EN 62061 and EN ISO 13849-1 standards. The safety function can also be used to implement Emergency Stop without contactors.

Remote monitoring

With a built-in web server and stand-alone datalogger, available remote monitoring options enables worldwide and secure access to drives.



Typical applications

Mixer

In mixing applications the drive provides a high starting torque. The silent operation mode adjusts the switching frequency of the drive to a higher level after the high-torque start, resulting in lower audible noise. The FlashDrop tool provides a quick and safe way to configure multiple drives for identical mixer applications.

Conveyor

Production lines often have multiple stages, including conveyors, which need to be efficiently linked with each other to provide high production output. A drive provides smooth start and stop of the conveyor, thereby reducing mechanical stress and lowering maintenance costs.

Packaging machine

Packaging machines often require a drive to provide a high degree of repeatability and accuracy during the packing operation. As such, the ACS355 is well suited for packaging duties and also provides good dynamic and static speed control accuracy. Sequence programming enables the drive to perform sequences of tasks, reducing the need for a PLC. Software features include timer, counter, brake control and jogging – all of which can be used in a packaging machine.

Bottling line

When filling the bottles with liquid, bottling lines require a drive which offers high accuracy. The ACS355 is perfect for this purpose, with its good dynamic and static speed control.

When dealing with liquids, the ACS355 with a high protection class (IP66) would also be a good choice.

Winders

The ACS355 offers high static speed accuracy. When dealing with thin strings like in string winders, it is essential to control the winder speed accurately in order to prevent the strings from snapping. Surface winders, on the other hand, require high static speed accuracy to keep control of the material thickness or tension.



How to select a drive

It is very easy to select the right drive.

This is how you build up your own ordering code using the type designation key.

- 1 Start with identifying your supply voltage.** This tells you what rating table to use. See page 8.
- 2 Choose your motor's power and current rating from the ratings table on page 8.**

Ratings and types

ACS355 - 03X - 02A4 - 2 - 2 - N300

Type designation
This is the unique reference number (shown above and in column 4 right that clearly identifies your drive by current rating and frame size. Once the drive's type designation has been selected, the frame size (column 5) can be used to determine the drive dimensions, shown on the next page.

Options and variant code
This code states the history installed or delivered (if not 000) and/or optional equipment selected for the drive. See page 14 - 25 for details.

Construction
"02" refers to the type of motor shown above (varies depending on the drive phase and EMC filtering. Choose below the drive phase).

EMC
EMC filter connected, 50 Hz frequency
EMC filter disconnected, 60 Hz frequency
(In case the filter is required it can easily be connected.)

Current rating
Current rating represents the rated continuous drive output current inside the drive specification. Motor power stated in the table below states the typical motor power.

Rating table

PN [kW]	PN [hp]	I2N [A]	Frame	Motor
0.37	0.5	2.4	100	100
0.75	1.0	4.7	112	112
1.1	1.5	6.7	132	132
1.5	2.0	7.5	143	143
2.2	3.0	9.8	160	160
3.0	3.0	13.3	180	180
4.0	5.0	17.6	200	200
5.5	7.5	24.4	225	225
7.5	10.0	31.0	250	250
11.0	15.0	46.2	280	280
0.37	0.5	1.2	100	100
0.55	0.75	1.9	112	112
0.75	1.0	2.4	132	132
1.1	1.5	3.3	143	143
1.5	2.0	4.1	160	160
2.2	3.0	5.6	180	180
3.0	3.0	7.3	200	200
4.0	5.0	8.8	225	225
5.5	7.5	12.5	250	250
7.5	10.0	15.6	280	280
11.0	15.0	23.1	315	315
15.0	20.0	31.0	355	355
18.5	25.0	38.0	400	400
22.0	30.0	44.0	450	450

Page 8

- 4 Choose your options (on pages 20 to 29) and add the option codes to drive's ordering code.** Remember to use a "+" mark before each option code.

Options

ACS355 - 03X - 02A4 - X - XXXX

Fieldbus

K451	DeviceNet™	FDNA-01
K452	LonWorks®	FLON-01
K454	PROFIBUS DP	FPBA-01
K457	CANopen®	FCAN-01

Pages 20 to 29

- 3 Select your drive's ordering code from the rating table based on your motor's nominal power rating.**

Ratings and types

ACS355 - 03X - 02A4 - 2 - 2 - N300

Type designation
This is the unique reference number (shown above and in column 4 right that clearly identifies your drive by current rating and frame size. Once the drive's type designation has been selected, the frame size (column 5) can be used to determine the drive dimensions, shown on the next page.

Options and variant code
This code states the history installed or delivered (if not 000) and/or optional equipment selected for the drive. See page 14 - 25 for details.

Construction
"02" refers to the type of motor shown above (varies depending on the drive phase and EMC filtering. Choose below the drive phase).

EMC
EMC filter connected, 50 Hz frequency
EMC filter disconnected, 60 Hz frequency
(In case the filter is required it can easily be connected.)

Current rating
Current rating represents the rated continuous drive output current inside the drive specification. Motor power stated in the table below states the typical motor power.

Rating table

PN [kW]	PN [hp]	I2N [A]	Frame	Motor
0.37	0.5	2.4	100	100
0.75	1.0	4.7	112	112
1.1	1.5	6.7	132	132
1.5	2.0	7.5	143	143
2.2	3.0	9.8	160	160
3.0	3.0	13.3	180	180
4.0	5.0	17.6	200	200
5.5	7.5	24.4	225	225
7.5	10.0	31.0	250	250
11.0	15.0	46.2	280	280
0.37	0.5	1.2	100	100
0.55	0.75	1.9	112	112
0.75	1.0	2.4	132	132
1.1	1.5	3.3	143	143
1.5	2.0	4.1	160	160
2.2	3.0	5.6	180	180
3.0	3.0	7.3	200	200
4.0	5.0	8.8	225	225
5.5	7.5	12.5	250	250
7.5	10.0	15.6	280	280
11.0	15.0	23.1	315	315
15.0	20.0	31.0	355	355
18.5	25.0	38.0	400	400
22.0	30.0	44.0	450	450

Page 8

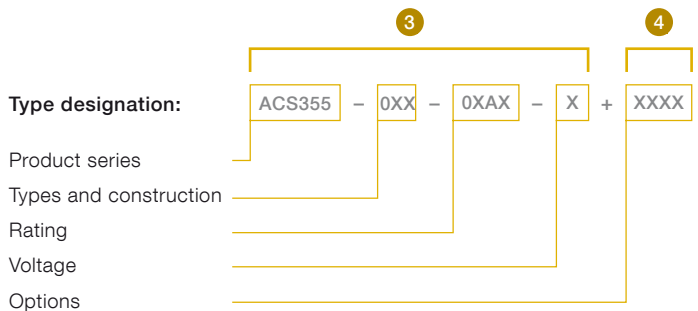

Ratings and types

ACS355 - 03E - 02A4 - 2 + N830

Type designation

This is the unique reference number (shown above and in column 4, right) that clearly identifies your drive by current rating and frame size. Once the drive's type designation has been selected, the frame size (column 5) can be used to determine the drive dimensions, shown on page 10.

Voltages

ACS355 is available in two voltage ranges:

2 = 200 to 240 V

4 = 380 to 480 V

Insert either "2" or "4", depending on your chosen construction, current rating, voltage, and option and variant codes into the type designation shown above.

Current rating

Current rating represents the rated continuous drive output current inside the drive specification. Motor power stated in the table below states the typical motor power.

Ratings IP20/UL Open type/ NEMA 1 option			Type designation	Frame size IP20	Frame size IP66
P_N [kW]	P_N [hp]	I_{2N} [A]			
1-phase AC supply, 200 to 240 V					
+B063					
0.37	0.5	2.4	ACS355-01X-02A4-2	R0	-
0.75	1.0	4.7	ACS355-01X-04A7-2	R1	-
1.1	1.5	6.7	ACS355-01X-06A7-2	R1	-
1.5	2.0	7.5	ACS355-01X-07A5-2	R2	-
2.2	3.0	9.8	ACS355-01X-09A8-2	R2	-
3-phase AC supply, 200 to 240 V					
+B063					
0.37	0.5	2.4	ACS355-03X-02A4-2	R0	R1
0.55	0.75	3.5	ACS355-03X-03A5-2	R0	R1
0.75	1.0	4.7	ACS355-03X-04A7-2	R1	R1
1.1	1.5	6.7	ACS355-03X-06A7-2	R1	R1
1.5	2.0	7.5	ACS355-03X-07A5-2	R1	R1
2.2	3.0	9.8	ACS355-03X-09A8-2	R2	R3
3.0	3.0	13.3	ACS355-03X-13A3-2	R2	R3
4.0	5.0	17.6	ACS355-03X-17A6-2	R2	R3
5.5	7.5	24.4	ACS355-03X-24A4-2	R3	-
7.5	10.0	31.0	ACS355-03X-31A0-2	R4	-
11.0	15.0	46.2	ACS355-03X-46A2-2	R4	-
3-phase AC supply, 380 to 480 V					
+B063					
0.37	0.5	1.2	ACS355-03X-01A2-4	R0	R1
0.55	0.75	1.9	ACS355-03X-01A9-4	R0	R1
0.75	1.0	2.4	ACS355-03X-02A4-4	R1	R1
1.1	1.5	3.3	ACS355-03X-03A3-4	R1	R1
1.5	2.0	4.1	ACS355-03X-04A1-4	R1	R1
2.2	3.0	5.6	ACS355-03X-05A6-4	R1	R1
3.0	3.0	7.3	ACS355-03X-07A3-4	R1	R1
4.0	5.0	8.8	ACS355-03X-08A8-4	R1	R1
5.5	7.5	12.5	ACS355-03X-12A5-4	R3	R3
7.5	10.0	15.6	ACS355-03X-15A6-4	R3	R3
11.0	15.0	23.1	ACS355-03X-23A1-4	R3	-
15.0	20.0	31.0	ACS355-03X-31A0-4	R4	-
18.5	25.0	38.0	ACS355-03X-38A0-4	R4	-
22.0	30.0	44.0	ACS355-03X-44A0-4	R4	-

Variant code

This code states the factory installed SW variants to the drive. See pages 16 - 19 for details.

Construction

"01E" within the type designation (shown above) varies depending on the drive phase and EMC filtering. Choose below the one you need.

01 = 1-phase

03 = 3-phase

E = EMC filter connected, 50 Hz frequency

U = EMC filter disconnected, 60 Hz frequency

(In case the filter is required it can easily be connected)

X within the type designation stands for E or U.

P_N for kW = Typical motor power in 400 V at normal use

P_N for hp = Typical motor power in 460 V at normal use

I_{2N} for A = Continuous rms current. 50% overload is allowed for one minute in ten minutes.

Technical data

ACS355

0XX

0XAX

X

XXXX

Mains connection

Voltage and power range	1-phase, 200 to 240 V \pm 10% 0.37 to 2.2 kW (0.5 to 3 hp) 3-phase, 200 to 240 V \pm 10% 0.37 to 11 kW (0.5 to 15 hp) 3-phase, 380 to 480 V \pm 10% 0.37 to 22 kW (0.5 to 30 hp)
Frequency	48 to 63 Hz

Common DC connection

Voltage and power range	230 V drives, 325 V \pm 15% 400/480 V drives, 540 \pm 15% (common DC manual) $P_{max} = P_n$ of the drive
--------------------------------	---

Motor connection

Voltage	3-phase, from 0 to U_{SUPPLY}
Frequency	0 to 599 Hz
Continuous loading capability (constant torque at a max. ambient temperature of 40 °C)	Rated output current I_{2N}
Overload capacity (at a max. ambient temperature of 40 °C)	1.5 x I_{2N} for 1 minute every 10 minutes At start 1.8 x I_{2N} for 2 s
Switching frequency Selectable	Default 4 kHz 4 to 16 kHz with 4 kHz steps
Acceleration time	0.1 to 1800 s
Deceleration time	0.1 to 1800 s
Braking	Built-in brake chopper as standard
Speed control Static accuracy Dynamic accuracy	20% of motor nominal slip < 1% s with 100% torque step
Torque control Torque step rise time Non-linearity	< 10 ms with nominal torque \pm 5% with nominal torque

Environmental limits

Ambient temperature	-10 to 40 °C (14 to 104 °F), no frost allowed 50 °C (122 °F) with 10% derating
Altitude	Rated current available at 0 to 1000 m. In altitudes from 1000 to 2000 m (3300 to 13,200 ft) above sea level, the derating is 1% for every 100 m (330 ft). If the installation site is higher than 2000 m (6600 ft) above sea level, please contact your local ABB distributor or office for further information.
Relative humidity	Lower than 95% (without condensation)
Degree of protection	IP20/optional NEMA 1/UL type 1 enclosure IP66/IP67/UL Type 4X as an option up to 7.5 kW, IP69K available for IP66/IP67 variant with compatible cable glands
Enclosure colour	NCS 1502-Y, RAL 9002, PMS 420 C
Contamination levels	IEC721-3-3 No conductive dust allowed Class 1C2 (chemical gases) Class 1S2 (solid particles)
Transportation	Class 2C2 (chemical gases) Class 2S2 (solid particles)
Storage	Class 3C2 (chemical gases) Class 3S2 (solid particles)
Operation	Class 3C2 (chemical gases) Class 3S2 (solid particles)

Product compliance

Low Voltage Directive 2006/95/EC
Machinery Directive 2006/42/EC
EMC Directive 2004/108/EC
Quality assurance system ISO 9001
Environmental system ISO 14001
UL, cUL, CE, C-Tick and GOST R approvals
RoHS compliant

Programmable control connections

Two analog inputs Voltage signal Unipolar Bipolar Current signal Unipolar Bipolar Potentiometer reference value Resolution Accuracy	0 (2) to 10 V, $R_{in} > 312 \text{ k}\Omega$ -10 to 10 V, $R_{in} > 312 \text{ k}\Omega$ 0 (4) to 20 mA, $R_{in} = 100 \Omega$ -20 to 20 mA, $R_{in} = 100 \Omega$ 10 V \pm 1% max. 10 mA, $R < 10 \text{ k}\Omega$ 0.1% \pm 2%
One analog output	0 (4) to 20 mA, load < 500 Ω
Auxiliary voltage	24 V DC \pm 10%, max. 200 mA
Five digital inputs Input impedance	12 to 24 V, PNP and NPN, programmable DI5 0 to 16 kHz pulse train 2.4 k Ω
One relay output Type Maximum switching voltage Maximum switching current Maximum continuous current	NO + NC 250 V AC/30 V DC 0.5 A/30 V DC; 5 A/230 V AC 2 A rms
One digital output Type Maximum switching voltage Maximum switching current Frequency Resolution Accuracy	Transistor output 30 V DC 100 mA/30 V DC, short circuit protected 10 Hz to 16 kHz 1 Hz 0.2%

Serial and Ethernet communication

Fieldbuses Refresh rate	Plug-in type < 10 ms (between drive and fieldbus module)
DeviceNet™	5-pin screw type connector, up to 500 kbit/s baud rate
PROFIBUS DP	9-pin D-connector, up to 12 Mbit/s baud rate
PowerLink	2 pcs RJ-45 connector, 100 Mbit/s baud rate
ControlNet™	2 pcs 8P8C modular jacks
CANopen®	9-pin D-connector, up to 1 Mbit/s
Modbus RTU	4-pin screw type connector, up to 115 kbit/s baud rate
EtherNet/IP™, Modbus TCP, PROFINET IO	1 RJ45 connector (FENA-01 and -11) or 2 RJ45 connectors (FENA-21). 10/100Mbit/s baud rate
LonWorks®	3-pin screw type connector, up to 78 kbit/s baud rate
EtherCAT®	2 pcs RJ-45 connectors, 100 Mbit/s baud rate

Chokes

AC input chokes	External option. For reducing THD in partial loads and to comply with EN/IEC 61000-3-12.
AC output chokes	External option. To achieve 2x longer motor cables

Dimensions and weights

ACS355 - OXX - OXAX - X + XXXX

Cabinet-mounted drives (IP20/UL Open)

Frame size	IP20/UL Open						Weight kg
	H1 mm	H2 mm	H3 mm	W mm	D1 mm	D2 mm	
R0	169	202	239	70	161	187	1.2
R1	169	202	239	70	161	187	1.2
R2	169	202	239	105	165	191	1.5
R3	169	202	236	169	169	195	2.5
R4	181	202	244	260	169	195	4.4

H1 = Height without fastenings and clamping plate

H2 = Height with fastenings but without clamping plate

H3 = Height with fastenings and clamping plate

W = Width

D1 = Standard depth

D2 = Depth with MREL, MPOW or MTAC option

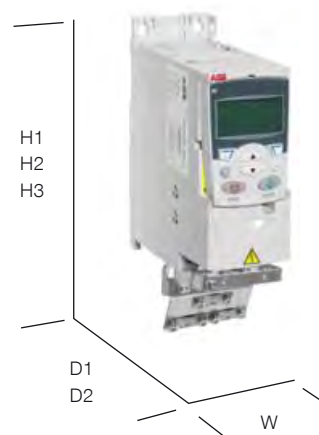

Wall-mounted drives (NEMA 1/UL Type 1)

Frame size	NEMA 1/UL Type 1					
	H4 mm	H5 mm	W mm	D1 mm	D2 mm	Weight kg
R0	257	280	70	169	187	1.6
R1	257	280	70	169	187	1.6
R2	257	282	105	169	191	1.9
R3	260	299	169	177	195	3.1
R4	270	320	260	177	195	5.0

H4 = Height with fastenings and NEMA 1 connection box

H5 = Height with fastenings, NEMA 1 connection box and hood

W = Width

D1 = Standard depth

D2 = Depth with MREL, MPOW or MTAC option



Wall-mounted drives (IP66/IP67/UL Type 4X)

Frame size	IP66/IP67/UL Type 4X			
	H mm	W mm	D1 mm	Weight kg
R1	305	195	281	7.7
R3	436	246	277	13

H = Height

W = Width

D1 = Standard depth





Cooling and fuses

Cooling

ACS355 is fitted with cooling fans as standard. The cooling air must be free from corrosive substances and must not be above the maximum ambient temperature of 40 °C (50 °C with derating). Heat dissipation from IP66/IP67/UL Type 4X drive equals to the IP20 UL Open values. For more specific limits see the Technical specification - Environmental limits in this catalog.

Cooling air flow

Type designation	Frame size	Heat dissipation		Air flow	
		[W]	BTU/hr ¹⁾	m ³ /h	ft ³ /min
1-phase AC supply, 200 to 240 V					
ACS355-01X-02A4-2	R0	48	163	- ²⁾	- ²⁾
ACS355-01X-04A7-2	R1	72	247	24	14
ACS355-01X-06A7-2	R1	97	333	24	14
ACS355-01X-07A5-2	R2	101	343	21	12
ACS355-01X-09A8-2	R2	124	422	21	12
3-phase AC supply, 200 to 240 V					
ACS355-03X-02A4-2	R0	42	142	- ²⁾	- ²⁾
ACS355-03X-03A5-2	R0	54	183	- ²⁾	- ²⁾
ACS355-03X-04A7-2	R1	64	220	24	14
ACS355-03X-06A7-2	R1	86	295	24	14
ACS355-03X-07A5-2	R1	88	302	21	12
ACS355-03X-09A8-2	R2	111	377	21	12
ACS355-03X-13A3-2	R2	140	476	52	31
ACS355-03X-17A6-2	R2	180	613	52	31
ACS355-03X-24A4-2	R3	285	975	71	42
ACS355-03X-31A0-2	R4	328	1119	96	57
ACS355-03X-46A2-2	R4	488	1666	96	57
3-phase AC supply, 380 to 480 V					
ACS355-03X-01A2-4	R0	35	121	- ²⁾	- ²⁾
ACS355-03X-01A9-4	R0	40	138	- ²⁾	- ²⁾
ACS355-03X-02A4-4	R1	50	170	13	8
ACS355-03X-03A3-4	R1	60	204	13	8
ACS355-03X-04A1-4	R1	69	235	13	8
ACS355-03X-05A6-4	R1	90	306	19	11
ACS355-03X-07A3-4	R1	107	364	24	14
ACS355-03X-08A8-4	R1	127	433	24	14
ACS355-03X-12A5-4	R3	161	551	52	31
ACS355-03X-15A6-4	R3	204	697	52	31
ACS355-03X-23A1-4	R3	301	1029	71	42
ACS355-03X-31A0-4	R4	408	1393	96	57
ACS355-03X-38A0-4	R4	498	1700	96	57
ACS355-03X-44A0-4	R4	588	2007	96	57

X within the type designation stands for E or U.

¹⁾ BTU/hr = British Thermal Unit per hour. BTU/hr is approximately 0.293 Watts.

²⁾ Frame size R0 with free convection cooling.

Free space requirements

Enclosure type	Space above	Space below	Space on left/right
	mm	mm	mm
All frame sizes	75	75	0
IP66/67 enclosure	75	75	20

Fuses

Standard fuses can be used with ABB machinery drives. For input fuse connections see table below. Also Manual Motor Protectors can be used to protect the installation. See user's manual for details.

Selection table

Type designation	Frame size	IEC fuses		UL fuses	
		[A]	Fuse type ^{*)}	[A]	Fuse type ^{*)}
1-phase AC supply, 200 to 240 V					
ACS355-01X-02A4-2	R0	10	gG	10	UL class T
ACS355-01X-04A7-2	R1	16	gG	20	UL class T
ACS355-01X-06A7-2	R1	16/20 ¹⁾	gG	25	UL class T
ACS355-01X-07A5-2	R2	20/25 ¹⁾	gG	30	UL class T
ACS355-01X-09A8-2	R2	25/35 ¹⁾	gG	35	UL class T
3-phase AC supply, 200 to 240 V					
ACS355-03X-02A4-2	R0	10	gG	10	UL class T
ACS355-03X-03A5-2	R0	10	gG	10	UL class T
ACS355-03X-04A7-2	R1	10	gG	15	UL class T
ACS355-03X-06A7-2	R1	16	gG	15	UL class T
ACS355-03X-07A5-2	R1	16	gG	15	UL class T
ACS355-03X-09A8-2	R2	16	gG	20	UL class T
ACS355-03X-13A3-2	R2	25	gG	30	UL class T
ACS355-03X-17A6-2	R2	25	gG	35	UL class T
ACS355-03X-24A4-2	R3	63	gG	60	UL class T
ACS355-03X-31A0-2	R4	80	gG	80	UL class T
ACS355-03X-46A2-2	R4	100	gG	100	UL class T
3-phase AC supply, 380 to 480 V					
ACS355-03X-01A2-4	R0	10	gG	10	UL class T
ACS355-03X-01A9-4	R0	10	gG	10	UL class T
ACS355-03X-02A4-4	R1	10	gG	10	UL class T
ACS355-03X-03A3-4	R1	10	gG	10	UL class T
ACS355-03X-04A1-4	R1	16	gG	15	UL class T
ACS355-03X-05A6-4	R1	16	gG	15	UL class T
ACS355-03X-07A3-4	R1	16	gG	20	UL class T
ACS355-03X-08A8-4	R1	20	gG	25	UL class T
ACS355-03X-12A5-4	R3	25	gG	30	UL class T
ACS355-03X-15A6-4	R3	35	gG	35	UL class T
ACS355-03X-23A1-4	R3	50	gG	50	UL class T
ACS355-03X-31A0-4	R4	80	gG	80	UL class T
ACS355-03X-38A0-4	R4	100	gG	100	UL class T
ACS355-03X-44A0-4	R4	100	gG	100	UL class T

X within the type designation stands for E or U.

^{*)} According to IEC-60269 standard.

¹⁾ If 50% overload capacity is needed, use the bigger fuse alternative.

Control connections



Application macros

Application macros are preprogrammed parameter sets. While starting up the drive, the user typically selects one of the macros that is best suited for the application. The diagram below gives an overview of ACS355 control connections and shows the default I/O connections for the ABB standard macro.

- Alternate macro
- AC500 Modbus macro
- Motor potentiometer macro
- Hand/auto macro
- PID control macro

ABB machinery drives have eight application macros:

- ABB standard macro
- Torque control macro
- 3-wire macro

In addition to the standard macros the user can create three user macros. The user macro allows the user to save the parameter settings for later use.

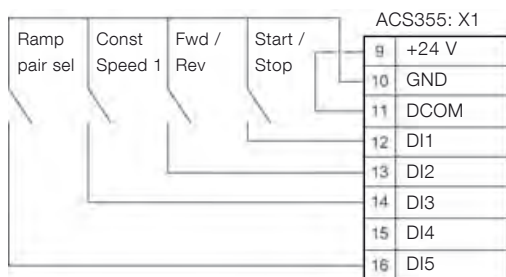
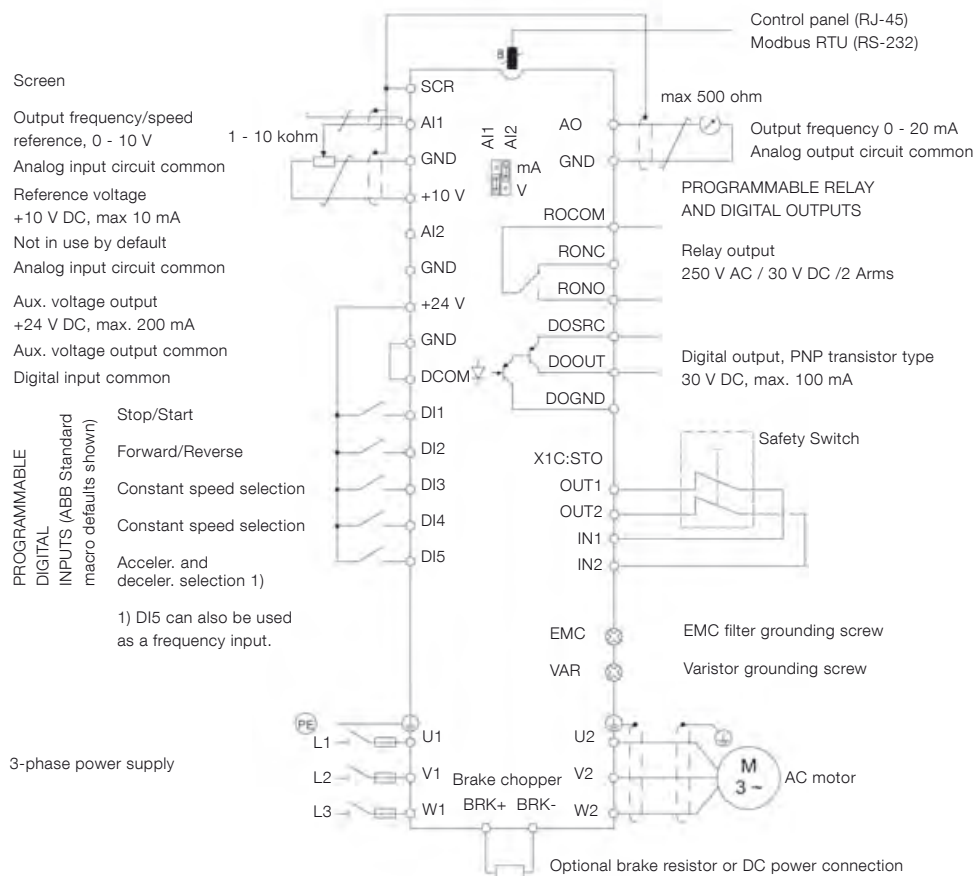

Sinking DI configuration (NPN connected).

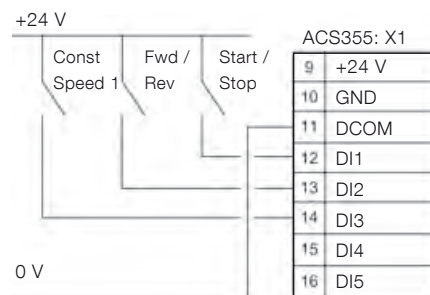

Sourcing DI configuration (PNP connected) with external power supply.

Control program example

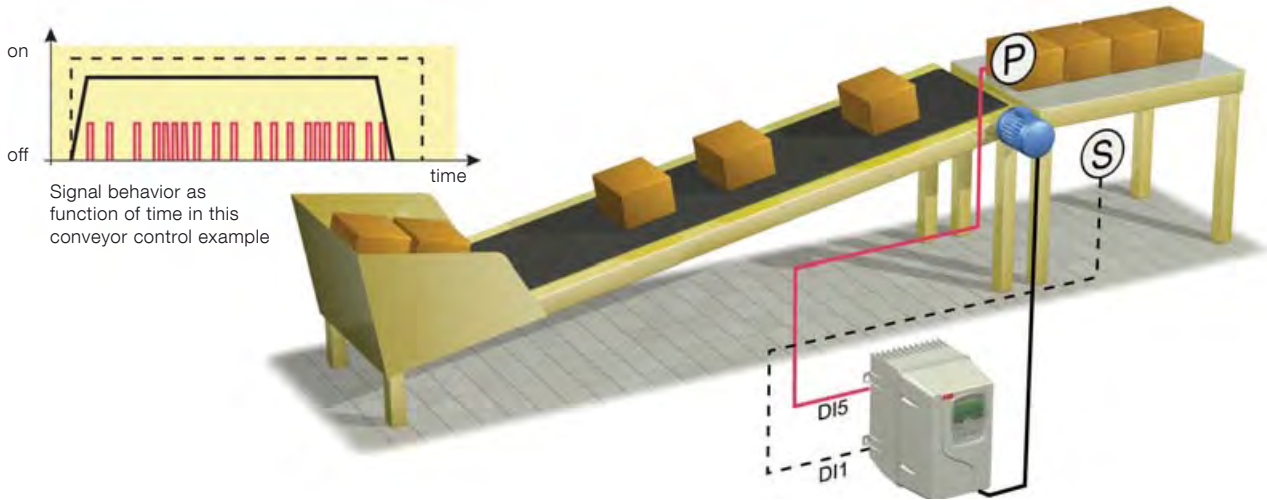

The ACS355 drives have many solutions for common challenges. The following example explains how the COUNTER STOP function operates within a conveyor unloading routine. The function stops the conveyor after a predefined number of boxes have passed the sensor.

The operator starts the conveyor by activating the drive using switch, S. The switch is connected to digital input 1 (DI1). The drive accelerates to a constant speed of 30 Hz with a 1 second ramp time.

Meanwhile a sensor, or proximity switch, P, is connected to digital input 5 (DI5). This sensor generates one pulse, every time a box on the conveyor passes by. When the required number of boxes – in this case 20 – have passed the sensor, the drive stops with a 1 second ramp time.

Parameter settings

Startup data

The correct motor parameters are set within parameter group 99. However, if the current and voltage settings of the motor and drive match, this is not necessary. The ACS355 also features vector control, which can be used by setting the relevant parameters and undertaking an ID run.

Start/Stop/Direction logic

Parameter 1001 EXT1 COMMANDS is set to COUNTER STOP [24]. Under certain conditions the counter output will modify the start/stop signal for stopping.

Constant speed selection

Parameter 1201 CONST SPEED SEL is set to DI1 [1]. Parameter 1202 CONST SPEED 1 acts as a speed reference source when digital input 1 is active.

Parameter 1202 CONST SPEED 1 is set to 30 Hz.

Start/Stop functions

Parameter 2101 START FUNCTION is set to AUTO [1], which is also the default value. If high torque is required for the conveyor to start, settings DC MAGN [2] can be used.

Parameter 2102 STOP FUNCTION is set to RAMP [2]. Thus the drive ramps down to 0 at a stop command.

Counter parametrization

Parameter 1904 COUNTER ENABLE is set to DI1 [1]. Counter is enabled now by digital input 1. When digital input 1 is low, the counter is not counting.

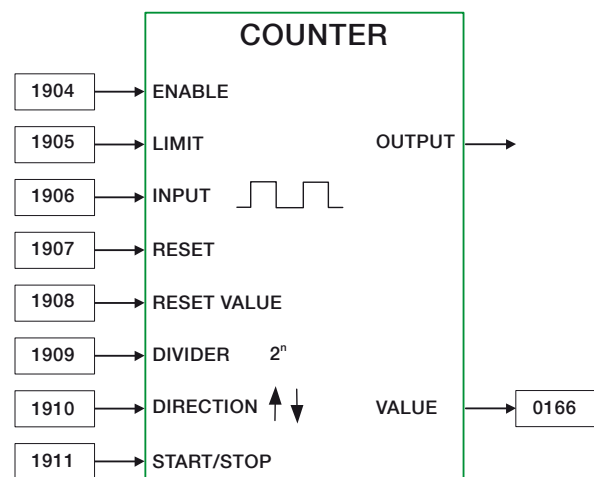

Control program example



Parameter 1905 COUNTER LIMIT is set to 20. In this example the loading station can only hold 20 boxes.

Parameter 1906 COUNTER INPUT is set to PLS IN (DI5) [1] which is also the default value. Pulse counter P is wired to digital input (DI5). This digital input can also handle high frequency pulses up to 10 kHz. If the counter signal edges are swinging, this parameter can be set to FILTERED DI5 [4].

Parameter 1907 COUNTER RESET is set to DI1 (INV) [-1]. When digital input 1 is low, the counter is reset to a value determined by parameter 1908 COUNTER RES VAL.

Parameter 1908 COUNTER RES VAL is set to zero, which is also the default value. The counter, in this example, runs from 0 to 20.

Parameter 1909 COUNT DIVIDER is set to zero, which is also the default value. This value is used to divide high frequency pulse numbers to lower values. For example a 1024 pulse incremental encoder would give 1024 pulses in one revolution. When using count divider 10 (2 to the power of 10) the counter would count up by 1 after 1024 pulses.

Parameter 1910 COUNT DIRECTION is set to UP [0], which is also the default value.

Parameter 1911 CNTR S/S COMMAND is set to DI1 [1]. Digital input 1 acts as the drive start command. Due to the setting of parameter 1001 EXT1 COMMANDS, the drive stops when the counter limit has been reached or digital input 1 goes low.

The counter's actual value can now be seen from signal 0166.

Acceleration and deceleration settings

Parameter 2201 ACC/DEC 1/2 SEL is set to NOT SEL [0]. Only one ramp is used in this application, thereby ramp changing is disabled.

Parameter 2202 ACCELER TIME 1 is set to 1s.

Parameter 2203 DECELER TIME 2 is set to 1s.

ACS355 control program functions

ACS355 control program provides the following functions:

- Counter start and stop
- Timer start and stop
- Speed compensated stop
- 3 independent supervision functions
- Automatic restart function
- 2 sets of ramping times
- S-curve for ramping
- 7 constant speeds
- 3 critical speed ranges
- Maintenance triggers
- Timed functions
- Configurable fault/protection functions
- 2 process PID functions
- PID sleep function
- PID trim function
- Mechanical brake control
- 8 state sequence programming
- 2 sets of user parameter sets
- Safe torque off
- Parameter lock

The ACS355 features the following motor control functions:

- Current, torque, speed and frequency limits
- Under- and overvoltage controllers
- Starting to the rotating machine
- Linear, squared and user defined U/f curves for scalar control
- IR compensation for scalar control
- Flux optimization for energy saving
- Flux braking for improved ramping down
- Drive temperature controlled switching frequency control
- Motor noise smoothing
- Sensorless vector control for induction motors
- Sensorless vector control for permanent magnet motors
- Smooth starting function for permanent magnet motors
- PID speed controller in vector controlled mode
- Acceleration compensation
- Speed controller auto tune
- Stand-alone and rotating motor identification runs
- Optional speed feed back for closed loop vector control

Control program variants

ACS355 - 0XX - 0XAX - X + N826



High speed application +N826

ACS355 high speed variant offers possibility to run the motor up to 1400 Hz in scalar mode or up to 32000 rpm in vector control mode. Both asynchronous motors and permanent magnet synchronous motors can be run without encoder.

This firmware variant features speed controller tuning for different tools used in the spindle, as well as up to six user sets which can be used to store for example acceleration

and deceleration times. These make the drive suitable for spindle applications such as polishing, grinding and carving applications in glass, metal, plastic and wood working industries.

Following table shows the recommended drive selection parameters when using the drive with high speed motors.

Motor rated frequency range [Hz]		Minimum switching frequency	Recommended switching frequency	Switching frequency control (2607)	Minimum derating		Recommended derating		Max ambient temperature
					200 V drive	400 V drive	200 V drive	400 V drive	
0	300 to 600	4 kHz	8 kHz	0 = ON (LOAD)	No derating	No derating	90%	75%	40
300	800 to 1000	8 kHz	12 kHz	1 = ON	90%	75%	80%	50%	30
800	1400	12 kHz	12 kHz	1 = ON	80%	50%	80%	50%	30

Control program variants

ACS355 - OXX - OXAX - X + N830



Enhanced sequence programming +N830

ACS355 enhanced sequence programming variant extends sequence programming up to 16 states with additional features. The program enables simple point-to-point positioning with 4 different targets when driving towards counter targets.

Transitions between the states can be controlled with IO and also from the fieldbus. It is possible to limit the torque and speed inside the state in addition to the existing control out of the state such as controlling the relay or analog output signal. Using relay extension module enables control of all 4 relays.

The firmware variant suits best to applications requiring repeatability or fixed driving sequences. Such applications are barriers in traffic control, automatic warehouse conveyors, assembly line conveyors and lifting equipment.

Enhanced sequence programming is at its best when programmed and commissioned with DriveWindowLight software offering graphical interface to each sequence state and its controls.

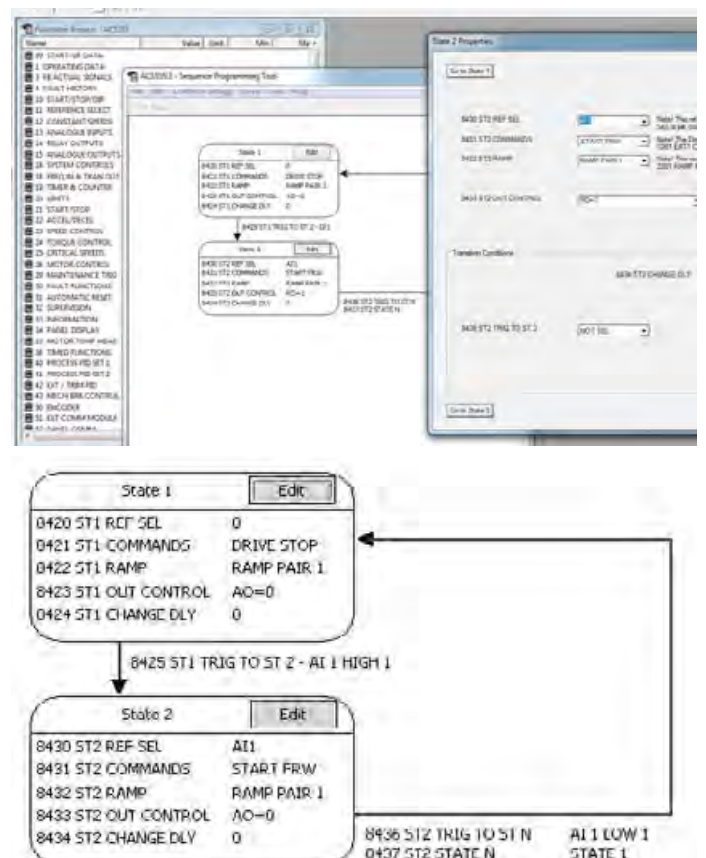

Product variants

ACS355 - OXX - OXAX - X + B063

High protection class drive +B063

A range of ABB machinery drives with IP66 protection is designed for applications exposed to dust, moisture and cleaning chemicals such as screws, mixers, pumps, fans and conveyors. Typical industries that benefit from the drive include food and beverage, textile, ceramics, pulp and paper, water and wastewater, printing and rubber and plastics.

The heat sink's cooling fins are completely open from top to bottom, which allows easy washing to ensure no dirt adheres to the surfaces. Assistant control panel housed within a plastic window is designed to resist moist and dusty atmospheres. Furthermore, the cooling fan is located inside the drive, thereby eliminating the need for an external cooling fan and the subsequent maintenance of external moving parts.

The drive's hygienic design and use of materials meeting current hygiene standards, means that the drive traps no bacteria and can withstand frequent washing. The drive is certified by NSF.



Mains connection, high protection class drive	
Voltage and power range	3-phase, 200 to 240 V \pm 10% 0.37 to 4 kW (0.5 to 5 hp) 3-phase, 380 to 480 V \pm 10% 0.37 to 7.5 kW (0.5 to 10 hp)
Common DC	Cannot be used with high degree protection class
Environmental limits, high protection class drive	
Ambient temperature	-10 to 40 °C (14 to 104 °F), no frost allowed
Degree of protection	IP66/IP67/UL Type 4X, indoor use only IP69K with compatible cable glands
Product compliance, high protection class drive	
Low Voltage Directive 2006/95/EC Machinery Directive 2006/42/EC EMC Directive 2004/108/EC Quality assurance system ISO 9001 Environmental system ISO 14001 UL, cUL, CE, C-Tick and GOST R approvals RoHS compliant NSF Certified DIN40050-9 (IP69K)	

Ratings			Type designation	Frame size
IP66/IP67/UL Type 4X				
P_N [kW]	P_N [hp]	I_{2N} [A]		
3-phase AC supply, 200 to 240 V				
0.37	0.5	2.4	ACS355-03X-02A4-2 + B063	R1
0.55	0.75	3.5	ACS355-03X-03A5-2 + B063	R1
0.75	1.0	4.7	ACS355-03X-04A7-2 + B063	R1
1.1	1.5	6.7	ACS355-03X-06A7-2 + B063	R1
1.5	2.0	7.5	ACS355-03X-07A5-2 + B063	R1
2.2	3.0	9.8	ACS355-03X-09A8-2 + B063	R3
3.0	4.0	13.3	ACS355-03X-13A3-2 + B063	R3
4.0	5.0	17.6	ACS355-03X-17A6-2 + B063	R3
3-phase AC supply, 380 to 480 V				
0.37	0.5	1.2	ACS355-03X-01A2-4 + B063	R1
0.55	0.75	1.9	ACS355-03X-01A9-4 + B063	R1
0.75	1.0	2.4	ACS355-03X-02A4-4 + B063	R1
1.1	1.5	3.3	ACS355-03X-03A3-4 + B063	R1
1.5	2.0	4.1	ACS355-03X-04A1-4 + B063	R1
2.2	3.0	5.6	ACS355-03X-05A6-4 + B063	R1
3.0	4.0	7.3	ACS355-03X-07A3-4 + B063	R1
4.0	5.0	8.8	ACS355-03X-08A8-4 + B063	R1
5.5	7.5	12.5	ACS355-03X-12A5-4 + B063	R3
7.5	10.0	15.6	ACS355-03X-15A6-4 + B063	R3

X within the type designation stands for E or U.

P_N for kW = Typical motor power in 400 V at normal use

P_N for hp = Typical motor power in 460 V at normal use

I_{2N} for A = Continuous rms current. 50% overload is allowed for one minute in ten minutes.

Product variants

ACS355 - OXX - OXAX - X + B827

Solar pump drive +N827

Solar pump system consists of a pump, photo voltaic (PV) panel system fitted to provide enough voltage and power to the pump, and solar pump drive converting the PV energy of DC voltage and DC current suitable for AC motor. Pump is very often submersible pump where motor is integrated to the pump itself.

ABB solar pump drive is environmentally friendly, with a long lifetime and low maintenance costs. It is independent from the grid and produces no pollution or noise. Typical applications are irrigation, community water supply, fish farming and agriculture.

This variant offers maximum power point tracking algorithm to maximize the solar panel output as well as water pumping specific functions such as dry running detection and flow calculation.



Ratings			Type designation	Frame size IP20	Typical losses W*)	MPPT voltage range		DC voltage range	
P_N kW	P_N hp	I_{2N} A				Min	Max	Min **)	Max ***)
1-phase AC supply, 125 to 400 V DC or 200 to 240 V									
0.37	0.5	4.7	ACS355-01E-04A7-2	R1	48	243	400	150	420
0.75	1.0	6.7	ACS355-01E-06A7-2	R1	68	243	400	150	420
1.1	1.5	7.5	ACS355-01E-07A5-2	R2	71	243	400	150	420
1.5	2.0	9.8	ACS355-01E-09A8-2	R2	90	243	400	150	420
3-phase AC supply, 125 to 400 V DC or 200 to 240 V									
0.37	0.5	3.5	ACS355-03E-03A5-2	R0	33	243	400	150	420
0.55	0.75	4.7	ACS355-03E-04A7-2	R1	41	243	400	150	420
0.75	1.0	6.7	ACS355-03E-06A7-2	R1	59	243	400	150	420
1.0	1.5	7.5	ACS355-03E-07A5-2	R1	61	243	400	150	420
1.5	2.0	9.8	ACS355-03E-09A8-2	R2	79	243	400	150	420
2.2	3.0	13.3	ACS355-03E-13A3-2	R2	50	243	400	150	420
3.0	4.0	17.6	ACS355-03E-17A6-2	R2	135	243	400	150	420
4.0	5.0	24.4	ACS355-03E-24A4-2	R3	219	243	400	150	420
5.5	7.5	31.0	ACS355-03E-31A0-2	R4	252	243	400	150	420
7.5	10.0	46.2	ACS355-03X-46A2-2	R4	380	243	400	150	420
3-phase AC supply, 250 to 800 V DC or 380 to 480 V									
0.37	0.5	1.9	ACS355-03E-01A9-4	R0	22	460	800	250	840
0.55	0.75	2.4	ACS355-03E-02A4-4	R1	28	460	800	250	840
0.75	1.0	3.3	ACS355-03E-03A3-4	R1	36	460	800	250	840
1.1	1.5	4.1	ACS355-03E-04A1-4	R1	43	460	800	250	840
1.5	2.0	5.6	ACS355-03E-05A6-4	R1	60	460	800	250	840
2.2	3.0	7.3	ACS355-03E-07A3-4	R1	75	460	800	250	840
3.0	4.0	8.8	ACS355-03E-08A8-4	R1	91	460	800	250	840
4.0	5.0	12.5	ACS355-03E-12A5-4	R3	119	460	800	250	840
5.5	7.5	15.6	ACS355-03E-15A6-4	R3	153	460	800	250	840
7.5	10.0	23.1	ACS355-03E-23A1-4	R3	232	460	800	250	840
11.0	15.0	31.0	ACS355-03E-31A0-4	R4	316	460	800	250	840
15.0	20.0	38.0	ACS355-03E-38A0-4	R4	388	460	800	250	840
18.5	25.0	44.0	ACS355-03E-44A0-4	R4	460	460	800	250	840

*) This is typical maximum losses of drive with basic control panel running at rated power at rated speed at rated conditions.

**) Operation is started with minimum voltage, but 100% AC current cannot be achieved before voltage is equal or higher than minimum MPPT voltage.

***) Panel open circuit voltage should be dimensioned so that it will never in any conditions exceed this level.

Options

ACS355 - OXX - OXAX - X + XXXX

Selecting options

The options shown in the table are available within the ACS355 range. The ordering code, which is shown in the second column, replaces the XXXX in the type designation above. You can order as many options as required, simply by extending the code as necessary.

Options	Ordering code	Description	Model	Availability	
				IP20 drive	IP66/67 drive
Protection class)	NEMA 1/UL type 1 (R0, R1, R2)	MUL1-R1	■	-
)	NEMA 1/UL type 1 (R3)	MUL1-R3	■	-
)	NEMA 1/UL type 1 (R4)	MUL1-R4	■	-
	B063	IP66/IP67/UL type 4X enclosure		-	■
Control panel (choose one option only)	J400	Assistant control panel	ACS-CP-A	□	●
	J404	Basic control panel	ACS-CP-C	□	-
Panel mounting kit)	Panel mounting kit	ACS/H-CP-EXT	□	-
)	Panel holder mounting kit	OPMP-01	□	-
Potentiometer	J402	Potentiometer	MPOT-01	□	-
Fieldbus (choose one option only)	K451	DeviceNet™	FDNA-01	□	□
	K452	LonWorks®	FLON-01	□	□
	K454	PROFIBUS DP	FPBA-01	□	□
	K457	CANopen®	FCAN-01	□	□
	K458	Modbus RTU	FMBA-01	□	□
	K462	ControlNet™	FCNA-01	□	□
	K466	1 port EtherNet/IP™, Modbus TCP, PROFINET IO	FENA-01	□	□
	K469	EtherCAT®	FECA-01	□	□
)	RS-485/Modbus	FRSA-00		
	K470	Ethernet PowerLink	FEPL-02	□	□
	K473	1 port EtherNet/IP™, Modbus TCP, PROFINET IO	FENA-11	□	□
	K475	2 port EtherNet/IP™, Modbus TCP, PROFINET IO	FENA-21	□	□
)	20 pack PROFIBUS DP for machinery drives	FPBA-01-M	□	□
)	20 pack CANopen for machinery drives	FCAN-01-M	□	□
Extension modules (choose one option only)	L502	Speed encoder module	MTAC-01	□	-
	L511	Relay output module	MREL-01	□	-
	G406	Auxiliary power extension module	MPOW-01	□	-
Remote monitoring)	Remote monitoring adapter	SREA-01	□	□
	3AUA0000094517	Remote monitoring adapter	NETA-21	□	□
High protection class options	H376	Cable gland kit (IP66/IP67/UL Type 4X)		-	□
	F278	Input switch kit (factory installed variant)		-	□
Pressure compensation	C169	Pressure compensation valve		-	□
Tools)	FlashDrop tool	MFDT-01	□	□
)	DriveWindow Light	DriveWindow Light	□	□
	P924 *)	PLC and AC drive starter kit		□	□
External options)	Input chokes		□	□ ¹⁾
)	EMC filters		□	□ ¹⁾
)	Braking resistors		□	□ ¹⁾
)	Output chokes		□	□ ¹⁾

● = standard

■ = product variant

□ = option, external

- = not available

) = To be ordered as a separate item.

*) = Available in selected countries.

¹⁾ External options not available in IP66/IP67/UL Type 4X protection class.

Options Interface

ACS355 - OXX - OXAX - X + XXXX

User interfaces

Panel cover

The purpose of the panel cover is to protect the drive's connection surfaces. The ACS355 drive is delivered with a panel cover as standard. In addition there are two alternative control panels available as options.

Basic control panel

The basic control panel features a single line numeric display. The panel can be used to control the drive, set the parameter values or copy them from one drive to another.

Assistant control panel

The assistant control panel features a multilingual alphanumeric display for easy drive programming. The control panel has various assistants and a built-in help function to guide the user. It includes a real time clock, which can be used during fault logging and in controlling the drive, such as start/stop. The control panel can be used for copying parameters for back up or for downloading to another drive. A large graphical display and soft keys make it extremely easy to navigate. The drive with IP66/IP67 enclosure has the assistant control panel as standard.

Potentiometer

Potentiometer MPOT-01 with two switches: start/stop and forward/reverse. Polarity is selected with DIP switches. No external power source is needed for the potentiometer.

Panel mounting kits

To attach the control panel to the outside of a larger enclosure, two panel mounting kits are available. A simple and cost-efficient installation is possible with the ACS/H-CP-EXT kit, while the OPMP-01 kit provides a more user-friendly solution, including a panel platform that enables the panel to be removed in the same way as a drive-mounted panel. The panel mounting kits include all hardware required eg, 3 m extension cables and installation instructions.



Panel cover (included as standard)



Basic control panel



Assistant control panel



Potentiometer



Panel holder mounting kit OPMP-01

Options Interface

ACS355 - OXX - OXAX - X + XXXX



Fieldbus module



NEMA 1/UL type 1 kit

Machine interfaces

The plug-in fieldbus modules bring connectivity to major automation systems. A single twisted pair cable avoids large amounts of conventional cabling, thereby reducing costs and increasing system reliability.

ACS355 supports the following fieldbus options:

- CANopen®
- ControlNet™
- DeviceNet™
- EtherCAT®
- EtherNet/IP™
- EtherNet PowerLink
- LonWorks®
- Modbus RTU
- Modbus TCP
- PROFIBUS DP
- PROFINET IO
- POWERLINK

Extension modules

MREL-01

ACS355 has one relay output as standard. The optional MREL-01 module offers three additional relay outputs, which can be configured for different functions with parameters.

MTAC-01

The optional MTAC-01 module offers pulse encoder interface for speed measurement.

MPOW-01

The optional auxiliary power module MPOW-01 enables the drive control circuitry to be operated under all conditions.

Protection and installation

NEMA 1/UL Type 1 kit

The NEMA 1/UL Type 1 kit includes a connection box for finger protection, conduit tube installation, and a hood for protection against dirt and dust.

Terminal cover

The terminal cover is for protection of the I/O connections.

Clamping plates

The clamping plates are used for protection against electrical disturbances. The clamping plates with clamps are included in the drive package as standard.

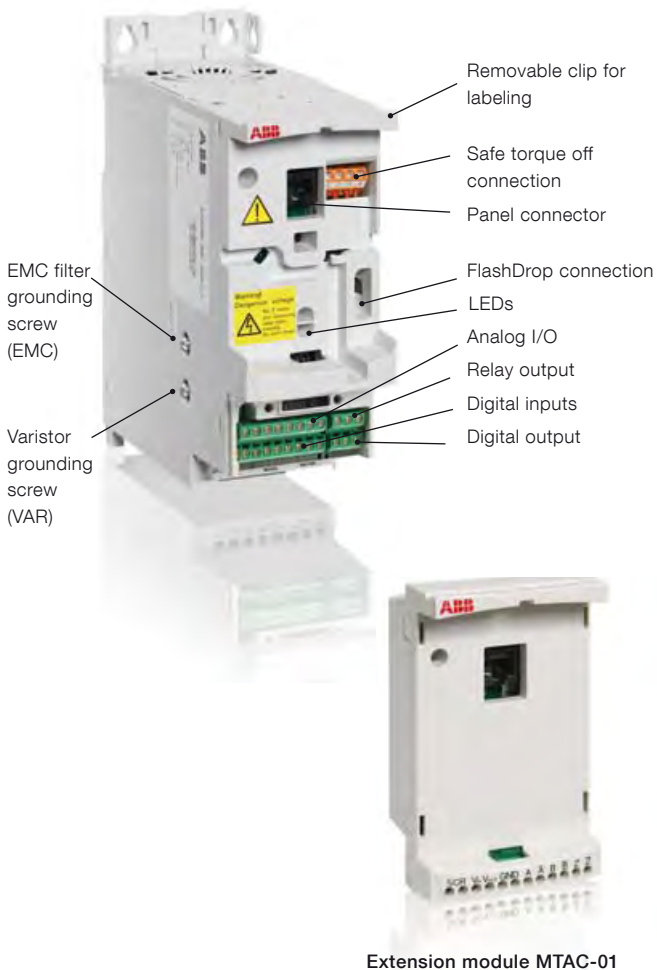

Extension module MTAC-01

Options

Software tools

ACS355 - OXX - OXAX - X + XXXX

A separate order line and type code is required for any of these software tool options.

Automation Builder

Automation Builder is an integrated programming, maintenance and simulation environment for PLCs, safety products, robots, motion products, drives and control panels. It combines the proven ABB tools RobotStudio, Drive Manager, Mint WorkBench, Panel Builder and succeeds Control Builder Plus, and enables use in IEC 61131-3, PLCopen, C/ C++, RAPID and MINT programming languages.

Automation Builder minimizes your efforts for managing project code and data with common data storage, single project archive, time saving library blocks for device integration, and a common software installer. The software includes easy to use libraries for applications in wind, water, solar, drives, motion, robotics and safety.

Making a joint backup with Automation Builder helps you to secure and restore your applications. Download Automation Builder from www.abb.com/automationbuilder for 30 days test license.

Drive Manager

Drive Manager offers machine builders and system integrators a device tool to configure and monitor ABB's low voltage AC drives and AC500 PLCs. The software is included in the Automation Builder engineering environment. Engineering drives and PLCs in one environment simplifies work, and saves commissioning time and cost.



Options

Software tools

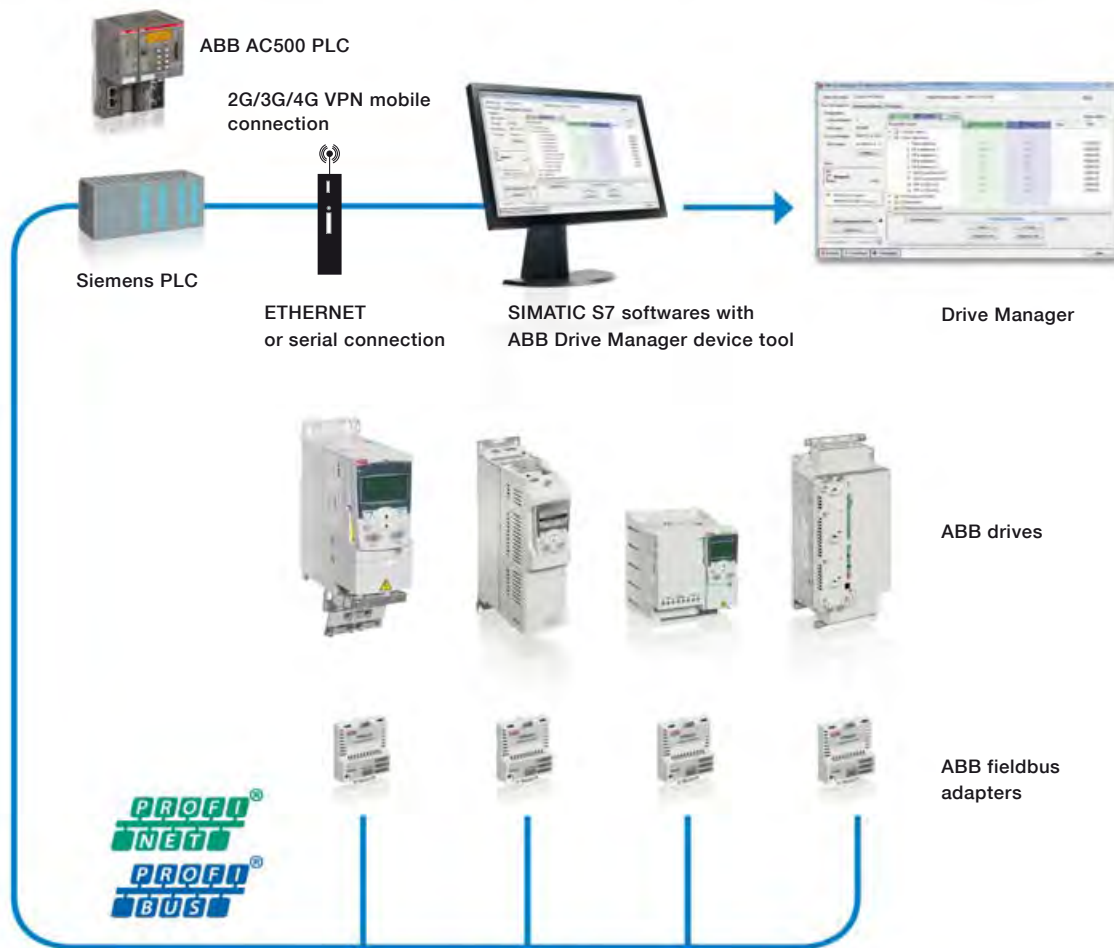

Drive Manager for SIMATIC (DM4S-01)

Drive Manager for SIMATIC is a plug-in device tool that can be easily installed into the SIMATIC STEP 7 engineering environment and TIA Portal. It utilizes the TCI interface of the SIMATIC PLC to communicate with the drives connected to PROFIBUS or PROFINET network. The setup enables engineering ABB's low voltage AC drives from the SIMATIC environment without the need for a separate ABB specific PC tool.

Function block library

ABB offers a function block library to enable easy integration of ABB low voltage drives in the SIMATIC S7 environment. The function block library is available from the ABB website (document number: 3AUA0000099358). The ZIP package includes manuals, examples and GSD files that can be imported to the SIMATIC S7 environment.

Ready-made features to your advantage

Drive Manager for SIMATIC offers several useful features that simplify the setup of ABB low voltage drives used in combination with SIMATIC S7 PLCs including:

- Network connection over PROFIBUS and PROFINET (single point of access) both locally and remotely
- Online and offline configuration of drives

- Monitoring of drive actual values
- Export to/import from the drive dedicated PC tools
- Saving drive parameter settings within the SIMATIC PLC project
- Remote connection to drives via PLC for diagnostics, parameterization, oscilloscope

Remote use

DriveManager for AC500 and SIMATIC S7 PLCs also enables remote use of drives, PLCs and HMI panels. "Plug-and-play" ready 2G/3G/4G mobile solution with dynamic IP address management and VPN tunneling makes commissioning easier without any PC softwares.

Remote connection to all functionalities of PLCs and HMIs includes:

- Remote connection to drives via PLC for diagnostics, parameterization, oscilloscope
- Data reading/writing
- Online and offline programming
- Extensive fault diagnostics
- Controlled update of firmware
- Download/upload of logged data on SD card
- Web Server
- FTP

Options

Software tools

DriveWindow Light

DriveWindow Light is an easy-to-use commissioning and maintenance tool for ACS355 drives. It can be used in an offline mode, which enables parameter setting at the office even before going to the actual site. The parameter browser enables viewing, editing and saving of parameters. The parameter comparison feature makes it possible to compare parameter values between the drive and saved parameter files. With the parameter subset you can create your own parameter sets. Controlling of the drive is naturally one of the features in DriveWindow Light. With this software tool, you can monitor up to four signals simultaneously. This can be done in both graphical and numerical format. Any signal can be set to stop the monitoring from a predefined level.

Sequence programming tool

DriveWindow Light allows the user to visually build and manipulate sequence programming parameters that are loaded into the ACS355. The programming is done in a graphical editor which displays each sequence step and its transitions as an individual block.

Sequence programming enables application specific programming with up to 8 configurable sequences. This new and easy way to preset sequences reduces the need for an external programmable logic control (PLC). In simple applications an external PLC can be left out.

Startup wizards

Startup wizards make the setting of parameters easy. Simply launch the wizard, select an appropriate assistant eg, for setting analog outputs, and all parameters related to this function are shown together with help pictures.

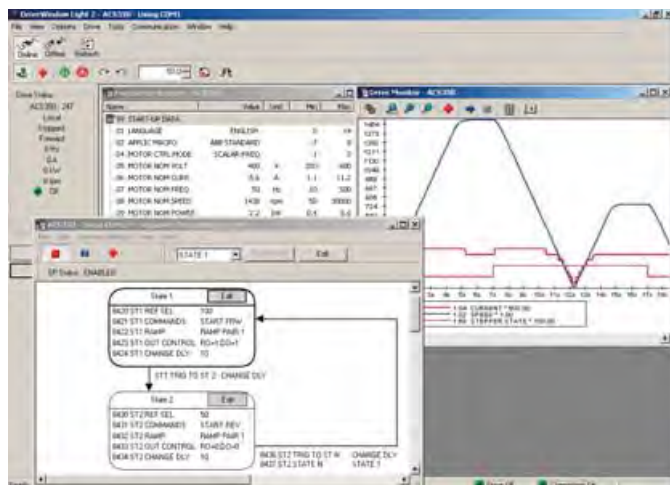

Highlights

- Graphical sequence programming tool for ACS355
- Editing, saving and downloading parameters
- Graphical and numerical signal monitoring
- Drive control
- Startup wizards

DriveWindow Light requirements

- Windows NT/2000/XP/Vista/7
- Free serial port from a PC
- Free control panel connector

Sequence programming example: radio button

In this example, analog input AI1 will start the motor at a fixed speed. This function is useful when the drive is operated using only a potentiometer. The motor speed is proportional to the analog input when analog input level is higher than the fixed level. In this case separate start and stop commands are not needed.

The analog input level is monitored using the ACS355's supervision function. Supervision function status is set as a transition rule between the two states of the sequence program.

In state 1 the drive is in stand-by, monitoring the AI1 level. In state 2 the drive starts in the forward direction and its reference is from AI1. In state 2, the supervision function monitors the AI1 level. If the value falls below the set limit, the sequence program makes a transition to state 1 and the drive is stopped.

There are two ramp pairs from which different ramping times can be selected within each state. It is also possible within the sequence program to control the analog output, digital output and relay output independently.

Supervision function, AI1 scaling to speed reference, and ramp times, can be set independent of the sequence program.

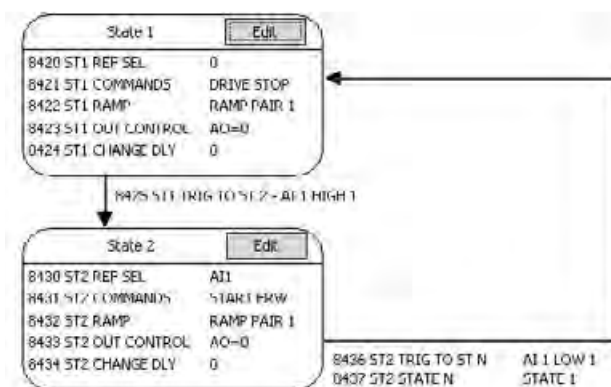

Options External

A separate order line and type designation is required for any of these external options.

FlashDrop tool

FlashDrop is a powerful palm sized tool for fast and easy parameter selecting and setting. It gives the possibility to hide selected parameters to protect the machine. Only the parameters needed in the application are shown. The tool can copy parameters between two drives or between a PC and a drive. All the above can be done without a power connection to the drive – in fact, it is not even necessary to unpack the drive.

DrivePM

DrivePM (drive parameter manager) is a tool to create, edit and copy parameter sets for the FlashDrop tool. For each parameter/group the user has a possibility to hide it, which means that the drive user does not see the parameter/group at all.

DrivePM requirements

- Windows 2000/XP/Vista/7
- Free serial port from a PC

FlashDrop package includes

- FlashDrop tool
- DrivePM software on a CD-ROM
- User's manual in English and in pdf-format on the CD-ROM
- Cable OPCA-02 for connection between the PC and FlashDrop tool
- Battery charger



Brake resistors

ACS355 is delivered with an integrated brake chopper as standard. Therefore no additional space or installation time is needed. The brake resistor is selected using the table below. For more information about the selection of brake resistors, see the ACS355 user's manual.

Brake chopper limits and resistor selection table

Type designation	R_{min} [ohm]	P_{BRmax} [kW] [hp]		Selection table by resistor type						Braking time ¹⁾ [s]
				CBR-V / CBT-H 2						
ACS355-				160	210	260	460	660	560	
1-phase AC supply, 200 to 240 V										
01X-02A4-2	70	0.37	0.5	●						90
01X-04A7-2	40	0.75	1	●						45
01X-06A7-2	40	1.1	1.5	●						28
01X-07A5-2	30	1.5	2	●						19
01X-09A8-2	30	2.2	3	●						14
3-phase AC supply, 200 to 240 V										
03X-02A4-2	70	0.37	0.5	●						90
03X-03A5-2	70	0.55	0.75	●						60
03X-04A7-2	40	0.75	1	●						42
03X-06A7-2	40	1.1	1.5	●						29
03X-07A5-2	30	1.5	2	●						19
03X-09A8-2	30	2.2	3	●						14
03X-13A3-2	30	3	4				●			16
03X-17A6-2	30	4	5				●			12
03X-24A4-2	18	5.5	7.5						●	45
03X-31A0-2	7	7.5	10						●	35
03X-46A2-2	7	11	15						●	23
3-phase AC supply, 380 to 480 V										
03X-01A2-4	200	0.37	0.5		●					90
03X-01A9-4	175	0.55	0.75		●					90
03X-02A4-4	165	0.75	1		●					60
03X-03A3-4	150	1.1	1.5		●					37
03X-04A1-4	130	1.5	2		●					27
03X-05A6-4	100	2.2	3		●					17
03X-07A3-4	70	3	4				●			29
03X-08A8-4	70	4	5				●			20
03X-12A5-4	40	5.5	7.5				●			15
03X-15A6-4	40	7.5	10				●			10
03X-23A1-4	30	11	15					●		10
03X-31A0-4	16	15	20						●	16
03X-38A0-4	13	18.5	25						●	13
03X-44A0-4	13	22	30						●	10

X within the type designation stands for E or U.

¹⁾ Braking time = Maximum allowed braking time in seconds at P_{BRmax} every 120 seconds, at 40 °C ambient temperature

²⁾ Availability varies depending on region.

Ratings by resistor type	CBR-V 160	CBR-V 210	CBR-V 260	CBR-V 460	CBR-V 660	CBT-H 560
Nominal power [W]	280	360	450	790	1130	2200
Resistance [ohm]	70	200	40	80	33	18

Options External

A separate order line and type designation is required for any of these external options.

Input chokes

Input choke smooths the wave shape of mains current and reduces total harmonic distortion (THD). Together with the input choke, the ACS355 is designed to fulfill the requirements of the harmonics standard EN/IEC 61000-3-12. In addition, the input choke provides improved protection against mains voltage transients.

Type designation ACS355-	Frame size	Input choke	I_{IN} without choke [A]	I_{IN} with choke [A]	I_{TH} [A]	L [mH]
1-phase AC supply, 200 to 240 V						
01X-02A4-2	R0	CHK-A1	6.1	4.5	5	8.0
01X-04A7-2	R1	CHK-B1	11.4	8.1	10	2.8
01X-06A7-2	R1	CHK-C1	16.1	11	16	1.2
01X-07A5-2	R2	CHK-C1	16.8	12	16	1.2
01X-09A8-2	R2	CHK-D1	21	15	25	1.0
3-phase AC supply, 200 to 240 V						
03X-02A4-2	R0	CHK-01	4.3	2.2	4.2	6.4
03X-03A5-2	R0	CHK-02	6.1	3.6	7.6	4.6
03X-04A7-2	R1	CHK-03	7.6	4.8	13	2.7
03X-06A7-2	R1	CHK-03	11.8	7.2	13	2.7
03X-07A5-2	R1	CHK-04	12	8.2	22	1.5
03X-09A8-2	R2	CHK-04	14.3	11	22	1.5
03X-13A3-2	R2	CHK-04	21.7	14	22	1.5
03X-17A6-2	R2	CHK-04	24.8	18	22	1.5
03X-24A4-2	R3	CHK-06	41	27	47	0.7
03X-31A0-2	R4	CHK-06	50	34	47	0.7
03X-46A2-2	R4	CHK-06	69	47	47	0.7
3-phase AC supply, 380 to 480 V						
03X-01A2-4	R0	CHK-01	2.2	1.1	4.2	6.4
03X-01A9-4	R0	CHK-01	3.6	1.8	4.2	6.4
03X-02A4-4	R1	CHK-01	4.1	2.3	4.2	6.4
03X-03A3-4	R1	CHK-01	6	3.1	4.2	6.4
03X-04A1-4	R1	CHK-02	6.9	3.5	7.6	4.6
03X-05A6-4	R1	CHK-02	9.6	4.8	7.6	4.6
03X-07A3-4	R1	CHK-02	11.6	6.1	7.6	4.6
03X-08A8-4	R1	CHK-03	13.6	7.7	13	2.7
03X-12A5-4	R3	CHK-03	18.8	11.4	13	2.7
03X-15A6-4	R3	CHK-04	22.1	11.8	22	1.5
03X-23A1-4	R3	CHK-04	30.9	17.5	22	1.5
03X-31A0-4	R4	CHK-05	52	24.5	33	1.1
03X-38A0-4	R4	CHK-06	61	31.7	47	0.7
03X-44A0-4	R4	CHK-06	67	37.8	47	0.7

I_{IN} = Nominal input current. When used in 480 V network I_{IN} is 20% lower with rated power.

I_{TH} = Nominal choke thermal current

L = Choke inductance

Output chokes

Output choke decreases du/dt on the drive output and filters current spikes caused by voltage spikes. Output filter also increases the maximum motor cable length.

Type designation ACS355-	Frame size	Output choke	Cable length [m]
1-phase AC supply, 200 to 240 V			
01X-02A4-2	R0	ACS-CHK-B3	60
01X-04A7-2	R1	ACS-CHK-B3	100
01X-06A7-2	R1	ACS-CHK-C3	100
01X-07A5-2	R2	ACS-CHK-C3	100
01X-09A8-2	R2	ACS-CHK-C3	100
3-phase AC supply, 200 to 240 V			
03X-02A4-2	R0	ACS-CHK-B3	60
03X-03A5-2	R0	ACS-CHK-B3	60
03X-04A7-2	R1	ACS-CHK-B3	100
03X-06A7-2	R1	ACS-CHK-C3	100
03X-07A5-2	R1	ACS-CHK-C3	100
03X-09A8-2	R2	ACS-CHK-C3	100
03X-13A3-2	R2	NOCH-0016-6x	100
03X-17A6-2	R2	NOCH-0016-6x	100
03X-24A4-2	R3	NOCH-0030-6x	100
03X-31A0-2	R4	NOCH-0030-6x	100
03X-46A2-2	R4	NOCH-0070-6x	100
3-phase AC supply, 380 to 480 V			
03X-01A2-4	R0	ACS-CHK-B3	60
03X-01A9-4	R0	ACS-CHK-B3	60
03X-02A4-4	R1	ACS-CHK-B3	100
03X-03A3-4	R1	ACS-CHK-B3	100
03X-04A1-4	R1	ACS-CHK-C3	100
03X-05A6-4	R1	ACS-CHK-C3	100
03X-07A3-4	R1	NOCH-0016-6x	100
03X-08A8-4	R1	NOCH-0016-6x	100
03X-12A5-4	R3	NOCH-0016-6x	100
03X-15A6-4	R3	NOCH-0016-6x	100
03X-23A1-4	R3	NOCH-0030-6x	100
03X-31A0-4	R4	NOCH-0030-6x	100
03X-38A0-4	R4	NOCH-0030-6x	100
03X-44A0-4	R4	NOCH-0070-6x	100

Options External

A separate order line and type designation is required for any of these external options.

EMC filters

The ACS355's internal EMC filter is designed to meet category C3 requirements of EN/IEC 61800-3 standard. External EMC filters are used to enhance the drives electromagnetic performance in conjunction with its internal filtering. Maximum motor cable length depends on required electromagnetic performance, according to the table below.

Type designation ACS355-	Frame size	Filter type	Cable length ¹⁾ with external EMC filter			Cable length ¹⁾ without external EMC filter	
			C1	C2	C3	C3	C4
			[m]	[m]	[m]	[m]	[m]
1-phase AC supply, 200 to 240 V							
01X-02A4-2	R0	RFI-11	10	30	-	30	30
01X-04A7-2	R1	RFI-12	10	30	50	30	50
01X-06A7-2	R1	RFI-12	10	30	50	30	50
01X-07A5-2	R2	RFI-13	10	30	50	30	50
01X-09A8-2	R2	RFI-13	10	30	50	30	50
3-phase AC supply, 200 to 240 V							
03X-02A4-2	R0	RFI-32 ²⁾	10	30	-	30	30
03X-03A5-2	R0	RFI-32 ²⁾	10	30	-	30	30
03X-04A7-2	R1	RFI-32 ²⁾	10	30	50	30	50
03X-06A7-2	R1	RFI-32 ²⁾	10	30	50	30	50
03X-07A5-2	R1	RFI-32 ²⁾	10	30	50	30	50
03X-09A8-2	R2	RFI-32 ²⁾	10	30	50	30	50
03X-13A3-2	R2	RFI-33	10	30	50	30	50
03X-17A6-2	R2	RFI-33	10	30	50	30	50
03X-24A4-2	R3	RFI-34	10	30	50	30	50
03X-31A0-2	R4	RFI-34	10	30	50	30	50
03X-46A2-2	R4	RFI-34	10	30	50	30	50
3-phase AC supply, 380 to 480 V							
03X-01A2-4	R0	RFI-32 ²⁾	30	30	-	30	30
03X-01A9-4	R0	RFI-32 ²⁾	30	30	-	30	30
03X-02A4-4	R1	RFI-32 ²⁾	50	50	50	30	50
03X-03A3-4	R1	RFI-32 ²⁾	50	50	50	30	50
03X-04A1-4	R1	RFI-32 ²⁾	50	50	50	30	50
03X-05A6-4	R1	RFI-32 ²⁾	50	50	50	30	50
03X-07A3-4	R1	RFI-32 ²⁾	50	50	50	30	50
03X-08A8-4	R1	RFI-32 ²⁾	50	50	50	30	50
03X-12A5-4	R3	RFI-33	40	40	40	30	50
03X-15A6-4	R3	RFI-33	40	40	40	30	50
03X-23A1-4	R3	RFI-33	40	40	40	30	50
03X-31A0-4	R4	RFI-34	-	30	-	30	50
03X-38A0-4	R4	RFI-34	-	30	-	30	50
03X-44A0-4	R4	RFI-34	-	30	-	30	50

¹⁾ Internal EMC filter must be connected with the EMC screw in the drive.

When the filter is not connected the C4 maximum cable lengths are allowed to be used.

²⁾ RFI-30 also available as footprint filter for frame size R0 and R1 with similar characteristics.

Low leakage current filters

Low leakage current filters are ideal for installations where residual current devices (RCD) are required and leakage current needs to be below 30 mA.

Type designation ACS355-	Frame size	Filter type	Cable length ¹⁾ with LRFI filter	
			C2	[m]
Low leakage current filters, 3-phase AC supply, 400 V				
03X-01A2-4	R0	LRFI-31		10
03X-01A9-4	R0	LRFI-31		10
03X-02A4-4	R1	LRFI-31		10
03X-03A3-4	R1	LRFI-31		10
03X-04A1-4	R1	LRFI-31		10
03X-05A6-4	R1	LRFI-31		10
03X-07A3-4	R1	LRFI-32		10
03X-08A8-4	R1	LRFI-32		10

¹⁾ Internal EMC filter must be disconnected by removing the EMC screw from the drive. RFI-11, RFI-12 and RFI-13 are also low leakage current filters.

EMC standards in general

EN 61800-3 (2004), product standard	EN 55011, product family standard for industrial, scientific and medical (ISM) equipment	EN 61800-3/A11 (2000), product standard
Category C1	Group 1 Class B	1 st environment, unrestricted distribution
Category C2	Group 1 Class A	1 st environment, restricted distribution
Category C3	Group 2 Class A	2 nd environment, unrestricted distribution
Category C4	Not applicable	2 nd environment, restricted distribution

Compact PLC and AC drive starter kit

ACS355

-

01E

-

02A4

-

2

+

P924

ABB's programmable logic controller (PLC) and AC drive starter kit offer an out-of-box motor control in minutes.

The compact, yet powerful kit, targets small-scale machines and systems requiring PLC control and up to seven drives.

Easy ordering and fast startup

Providing PLC, AC drive and accessories as a package simplifies ordering and provides quick deliveries. The ordering code for the starter kit is ACS355-01E-02A4-2+P924. Please note that the starter kit is available in selected countries.

The starter kit for evaluation and customization (application programming) includes:

- PLC AC500-eCo PM554-T (8 DI / 8 DO-Transistor)
- ACS355-01E-02A4-2 (single phase 230 V AC, with power of 0.37 kW) drive with ACS-CP-A assistant control panel and FMBA-01 Modbus fieldbus adapter
- MC502 SD card containing the AC500 function block library for drives with complete functional objects for easy and secure programming
- Several accessories such as MC503 SD card adapter, TA562-RS serial interface, TA571-SIM 6 switches simulator, TK503 communication cable between the PLC and the drive for programming

- Full version of PS501 Control Builder programming environment with all functionalities. Excludes sheet license to receive free software updates.
- A step-by-step guide for setting up the intuitive set

Ready-made reorder packages for ACS355 enables expansion of starter kit to a multiple drives system. AC500 product family offers several controllers for system scaling.

Benefits of the kit

- Control of a motor in minutes
- Easy ordering of PLC, AC drive and accessories as a kit from ABB's central stock
- Entry-level kit for learning the Control Builder programming environment based on IEC 61161-3 programming standard
- Pre-engineered communication libraries for all ABB LV AC drives
- Ready-made HMI visualization
- Cost-efficient system expansion, since the same application program can be used for the entire AC500 PLC platform



ABB automation products

Motion controllers

ABB offers a wide range of motion control products to suit many different applications. Motion controllers are available in PCI format, as stand-alone units with USB, CANopen®, serial and Ethernet interfaces and as intelligent programmable drives for use in single or multiaxis systems.



Control panels

Our control panels offer a wide range of touchscreen graphical displays from 3.5" up to 15". They are provided with user-friendly configuration software that enables tailor-made customized HMI solutions. Rich sets of graphical symbols and the relevant drivers for ABB automation products are provided. Control panels for visualization of AC500 web server applications are available.



Servo drives

ABB offers a range of servo drives to cover many different applications. Its drives range from simple analog, fieldbus controlled drives, indexing drives, fully programmable motion drives and real-time Ethernet solutions based on the open standard Ethernet PowerLink and EtherCAT®. ABB motion drives control rotary and linear AC servo motors, and are available from 1 A single phase through to 65 A three phase.



Servo motors

ABB's BSM series servo motors offer a wide choice of high or low inertia models with winding options, feedback devices and gearheads to match. All ABB servo motors are designed for durability and ability to handle harsh environments.



AC motors

ABB's low voltage AC motors are designed to save energy, reduce operating costs and enable demanding motor applications to perform reliably and without unscheduled downtime. General performance motors combine convenience and easy handling seamlessly with ABB's engineering expertise. Process performance motors provide the most comprehensive, versatile set of motors for the process industries and heavy-duty applications.



Machinery drives

ABB offers machinery builders AC drives from component drives up to high performance machinery drives. Global support and service guarantees lifelong satisfaction. ABB machinery drives provide speed control of diverse applications from spa bath motors to treadmill motors, as well as high precision applications such as positioning and synchronization systems.



Jokab safety products

ABB Jokab Safety offers an extensive range of innovative products and solutions for machine safety systems. It is represented in standardization organisations for machine safety and works daily with the practical application of safety requirements in combination with production requirements. ABB Jokab Safety delivers everything from a single safety solution to complete safety systems for single machines or entire production lines.



ABB automation products

AC500

ABB's powerful flagship PLC offering a wide range of performance levels and scalability within a single simple concept where most competitors require multiple product ranges to deliver similar functionality. Web server integrated and IEC 60870-5-104 remote control protocol for all Ethernet versions.



AC500-eCo

Meets the cost-effective demands of the small PLC market whilst offering total inter-operability with the core AC500 range. Web server, FTP server and Modbus-TCP for all Ethernet versions. A Pulse Train Out-put module is available for multi-axis positioning.



AC500-S

A PLC based modular automation solution that makes it easier than before to mix and match standard and safety I/O modules to meet your safety requirements in all functional safety applications. "Extreme conditions" version is also offered.



AC500-XC

"Extreme conditions" modules with extended operating temperature, immunity to vibration and hazardous gases, for use at high altitudes, in humid conditions, etc. It replaces expensive cabinets with its built-in protection against dirt, water, gases and dust.



Robotics

ABB's robotic automation offers cell automation by integrating AC500 PLCs in IRC5 robot controllers. More productivity with robots is achieved by wireless interfaces for sensors and actuators on robot tools. Wireless from ABB is an innovative, proven solution well-suited for robots, presses, rotary tables and gantries.



Programming software

Automation Builder integrates the engineering and maintenance for PLC, drives, motion products, HMI and robotics. It complies with the IEC 61131-3 standard offering all five IEC programming languages for PLC and drive configuration. In addition, it includes continuous function chart, C, extensive function block libraries and powerful embedded simulation/visualization features. Automation Builder supports a number of languages (English, German, French, Chinese, Spanish) and comes with new libraries, FTP functions, SMTP, SNTP, smart diagnostics and debugging capabilities.



I/O modules

Centralised I/O expansion of the AC500 line and decentralised modular I/O supporting CS31, CANopen®, PROFIBUS DP, PROFINET and EtherCAT®.



Drives service

Your choice, your future

The future of your drives depends on the service you choose.

Whatever you choose, it should be a well-informed decision. No guesswork. We have the expertise and experience to help you find and implement the right service for your drive equipment. You can start by asking yourself these two critical questions:

- Why should my drive be serviced?
- What would my optimal service options be?

From here, you have our guidance and full support along the course you take, throughout the entire lifetime of your drives.

Your choice, your business efficiency

ABB Drive Care agreement lets you focus on your core business. A selection of predefined service options matching your needs provides optimal, more reliable performance, extended drive lifetime and improved cost control. So you can reduce the risk of unplanned downtime and find it easier to budget for maintenance.

We can help you more by knowing where you are!

Register your drive at www.abb.com/drivereg for extended warranty options and other benefits.



Service to match your needs

Your service needs depend on your operation, life cycle of your equipment and business priorities. We have identified our customers' four most common needs and defined service options to satisfy them. What is your choice to keep your drives at peak performance?

Is uptime your priority?

Keep your drives running with precisely planned and executed maintenance.

Example services include:

- ✓ Life Cycle Assessment
- ✓ Installation and Commissioning
- ✓ Spare Parts
- ✓ Preventive Maintenance
- ✓ ABB Drive Care agreement

Is rapid response a key consideration?

If your drives require immediate action, our global network is at your service.

Example services include:

- ✓ Technical Support
- ✓ Drive Exchange
- ✓ On-site Repair
- ✓ Response time agreements

Need to extend your assets' lifetime?

Maximize your drive's lifetime with our services.

Example services include:

- ✓ Life Cycle Assessment
- ✓ Replacement, Disposal and Recycling

Is performance most critical to your operation?

Get optimal performance out of your machinery and systems.

Example services include:

- ✓ Training

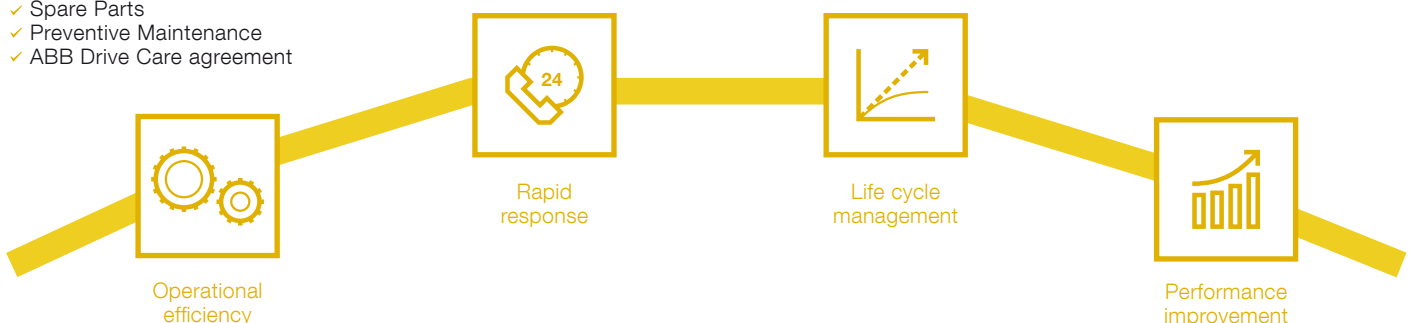

Drives service

A lifetime of peak performance

You are in control of every life cycle phase of your drives. At the heart of drive services is a four-phase product life cycle management model. This model defines the services recommended and available throughout the drive's lifespan.

Now it's easy for you to see the exact service and maintenance available for your drives.

ABB drives life cycle phases explained:

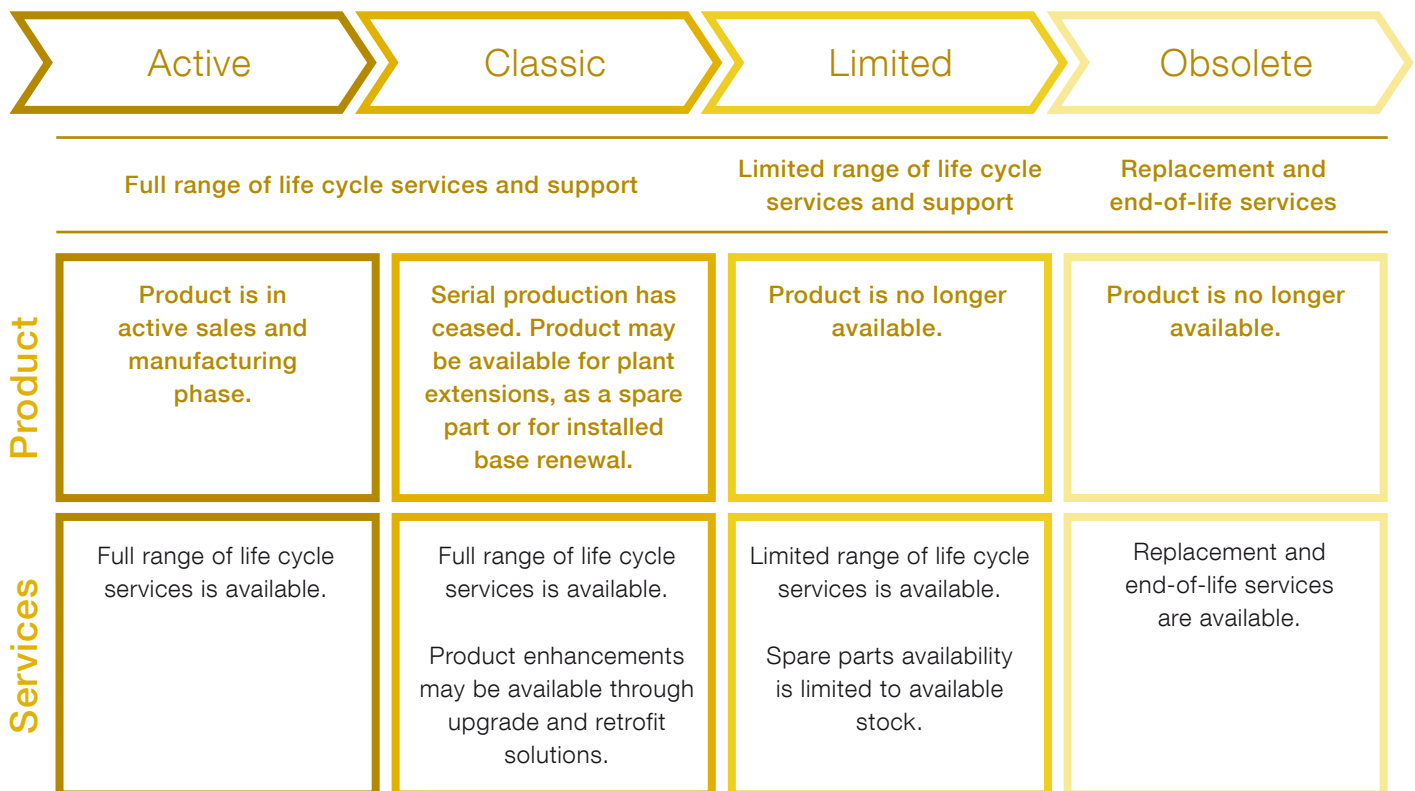

Keeping you informed

We notify you every step of the way using life cycle status statements and announcements.

Your benefit is clear information about your drives' status and precise services available. It helps you plan the preferred service actions ahead of time and make sure that continuous support is always available.

Step 1 Life Cycle Status Announcement

Provides early information about the upcoming life cycle phase change and how it affects the availability of services.

Step 2 Life Cycle Status Statement

Provides information about the drive's current life cycle status, availability of product and services, life cycle plan and recommended actions.

Notes

Lined area for notes, consisting of multiple horizontal dotted lines.

Notes

A large area of horizontal dotted lines for taking notes.

Contact us

For more information please contact your local ABB representative or visit:

www.abb.com/drives

www.abb.com/drivespartners

© Copyright 2017 ABB. All rights reserved.
Specifications subject to change without notice.

3AUAC000068569 REV G EN 19.1.2017

